

MINI KING LIGHT 1.0

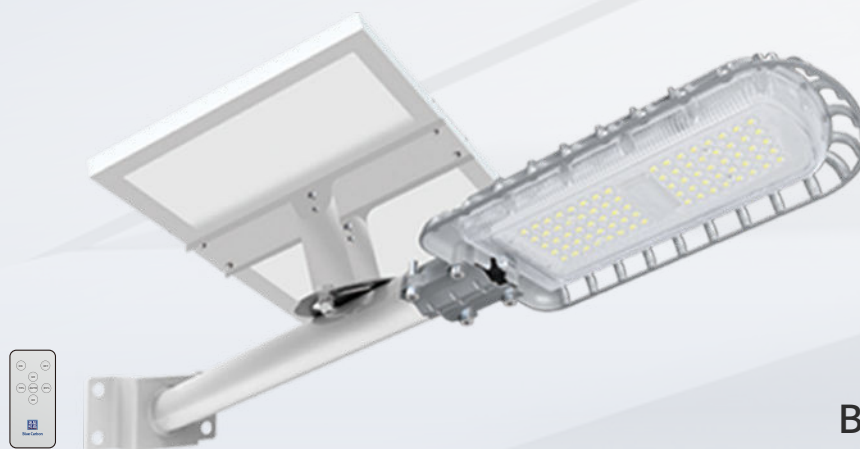

BCT-OLK1.0-M

Patent number: ZL2020 3 0548678.X



Light energy charging



Always bright on rainy days



Wide lighting range



Clean Energy

► Product Parameters

*Battery may be stored up to 3 months then a freshening charge is required.

Product name	20W Solar Mini King Light	
Model	BCT-OLK1.0-M	
Solar panel	25W	
Panel size	410×335×25×25 mm	
Battery	3.2V/25(±5)Ah LiFePO ₄ Battery	
Light power	2200lm (Common 20W LED)	
Lighting time	6+X/Intelligent power control, and can use remote control to adjust brightness and working mode.	
Installation height	4.5-5m	
Installation distance	15-20m	
Gross weight	5.5kg	
Lamp life	100000 hours	
Installation diameter	φ60(±3) mm	
Product size	472×210×56mm	
Beam angle	bat wing 150°70°	
CRI	Ra70	
Color temperature	6500K,4000K	
IP rating	IP65	
IK level	IK08	
Operating temperature	-40°C~70°C	
Working humidity	10%~90%	

*Note: The above data are typical values. The actual product weight will have an error of about 5%.

Product Display

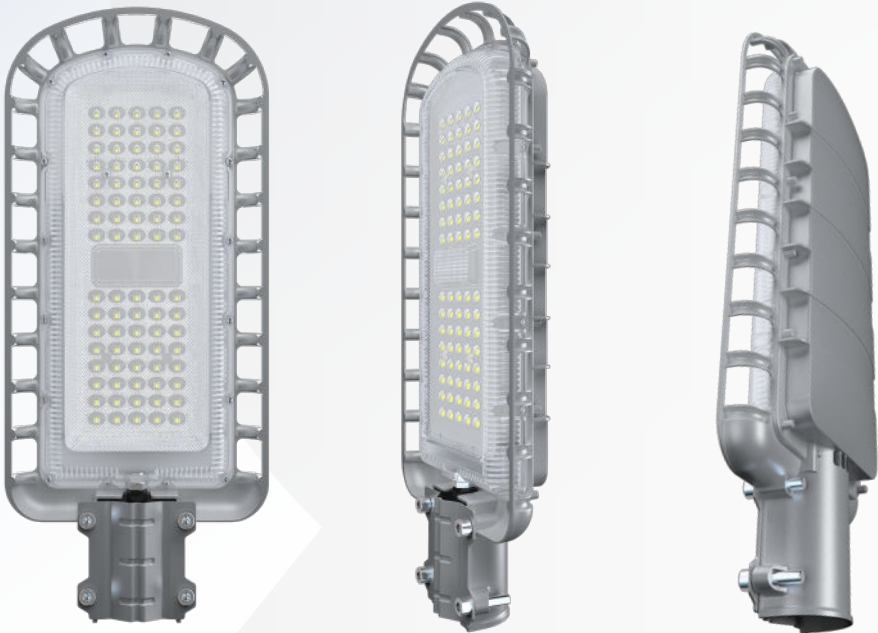

▶ Product Size:

- Lamp head size chart

Unit:mm

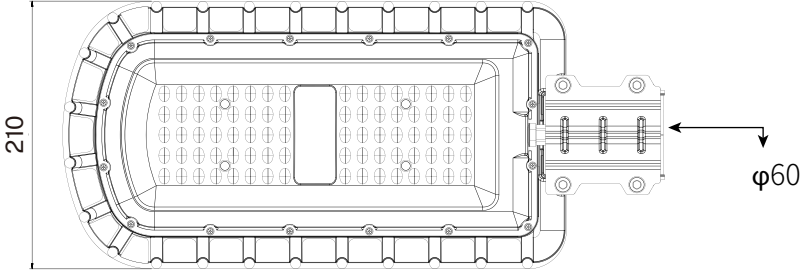
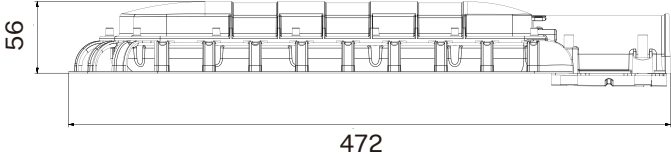

► Product Details Display

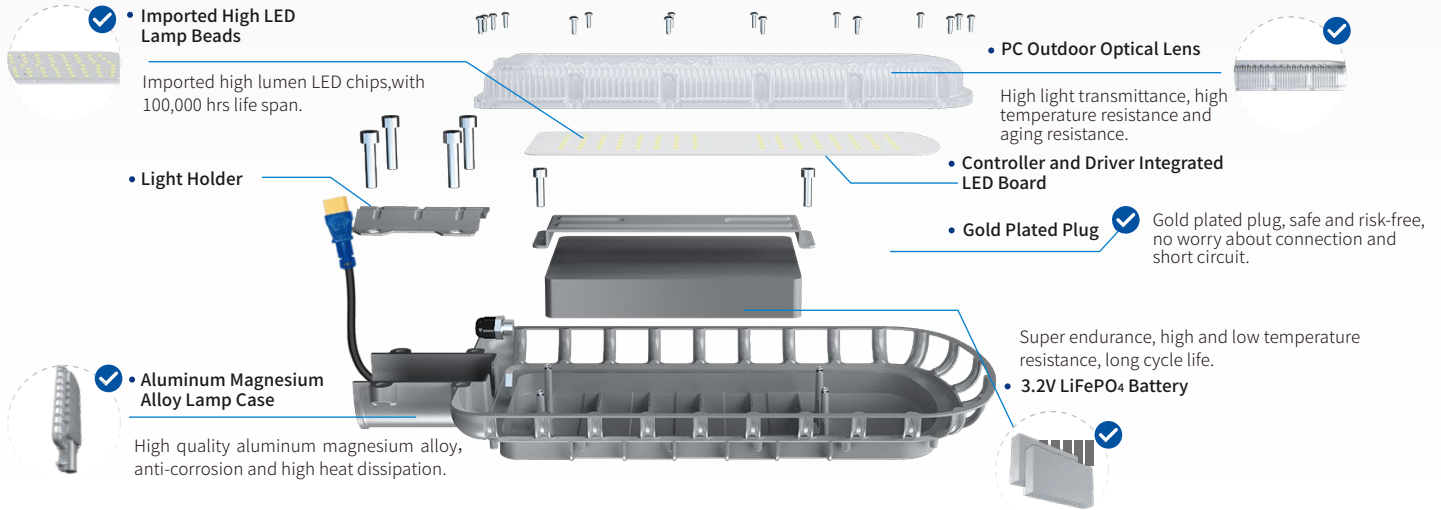

- Original patent design, independent mould.
- All night lighting. The light never be off no matter how many rainy or cloudy days.
- The light can be installed from Equator area to Polar regions. The working temperature is -40-70°C
- Integrated design, modular production.
- Low voltage design, safe and Reliable.
- Integrated package, convenient transportation.

► Installation Case

Applicable place:

It is widely used in streets and roads, residential areas, scenic spots, parks, squares, private gardens and other public places.

The product is easy to install, no auxiliary lines required, energy saving and environmental protection, no electricity charge, long service life.

Mini King Light 1.0

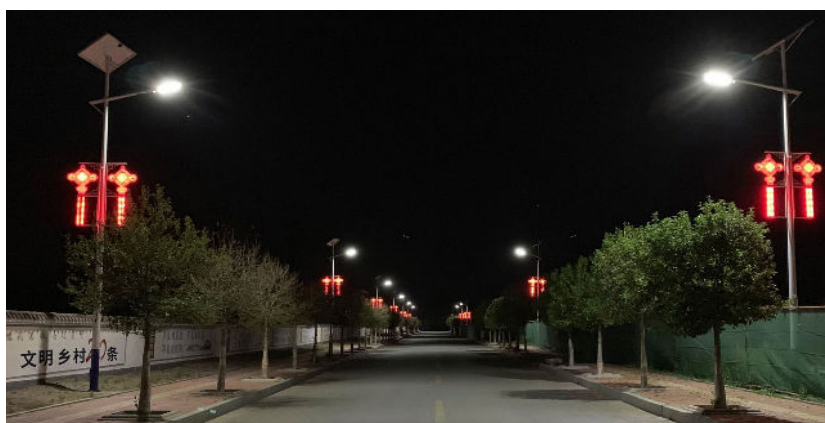
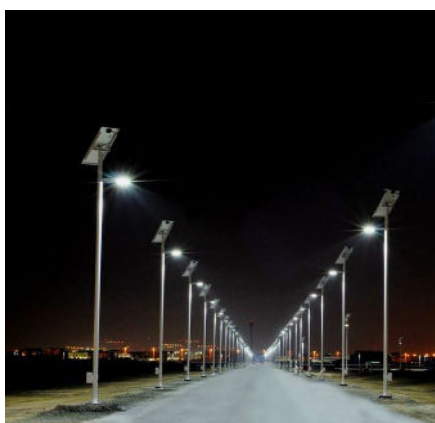

▲ China

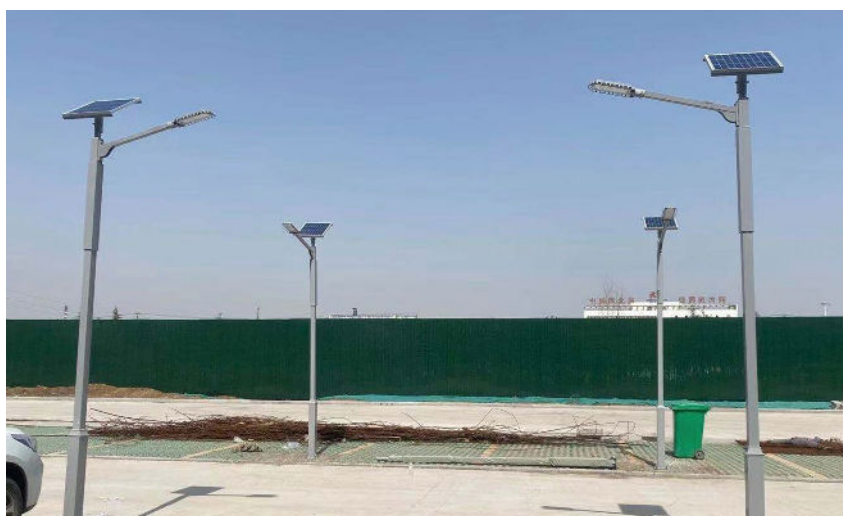

▲ China



▲ Uzbekistan